

1

03592105

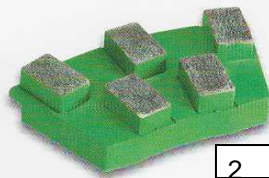

2

03592305

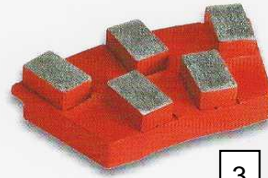

3

03592005

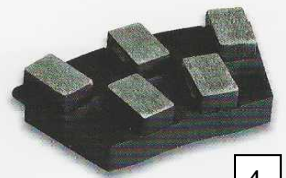

4

03592205



5

00565001



6

00566001



7

00567001



8

00569001



00120001

9



00571001

10



00577001

11



00125200

12

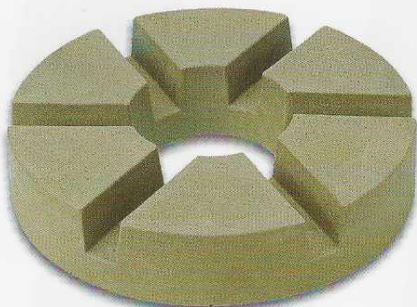

13

00549041

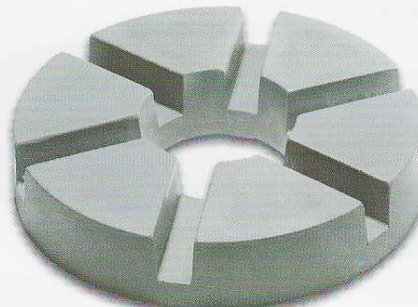

14

00553011

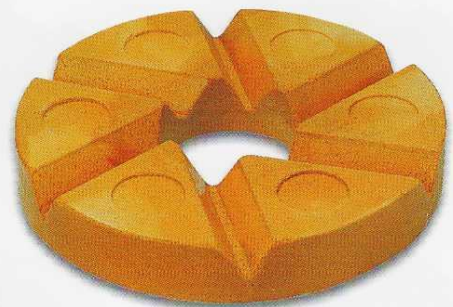

15

00551011



16

00557001

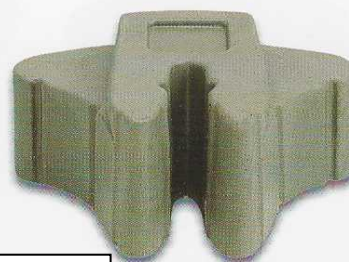

19

00559001



17

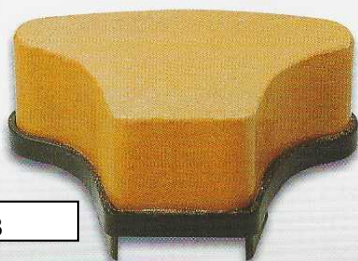

18



20



03582031 **21**



00545001 **22**

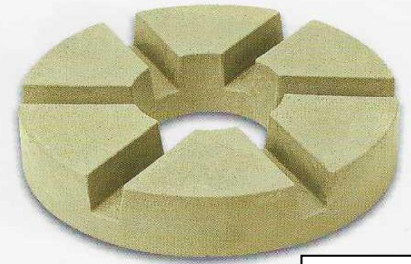

00547001 **23**



24 00110060



00110002 **25**

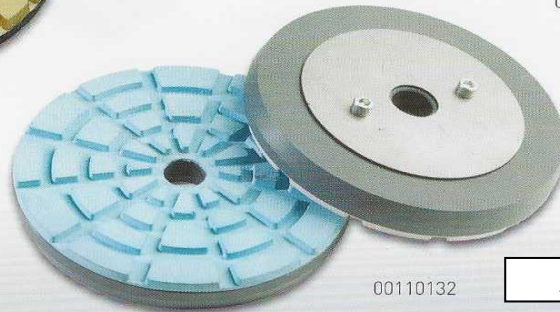

00110132 **26**



27

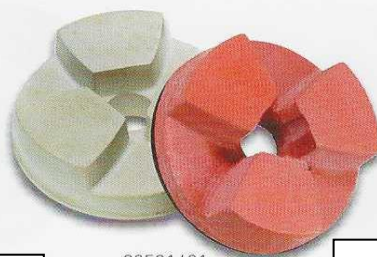

00591401 **28**



00591101 **29**



30 00592001

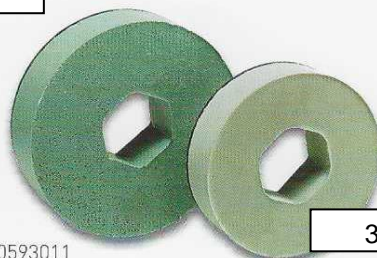

00593011 **31**

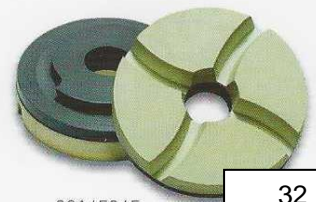

00145365 **32**

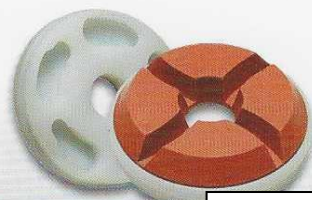

00145460 **33**



00146620 **34**



00147730 **35**



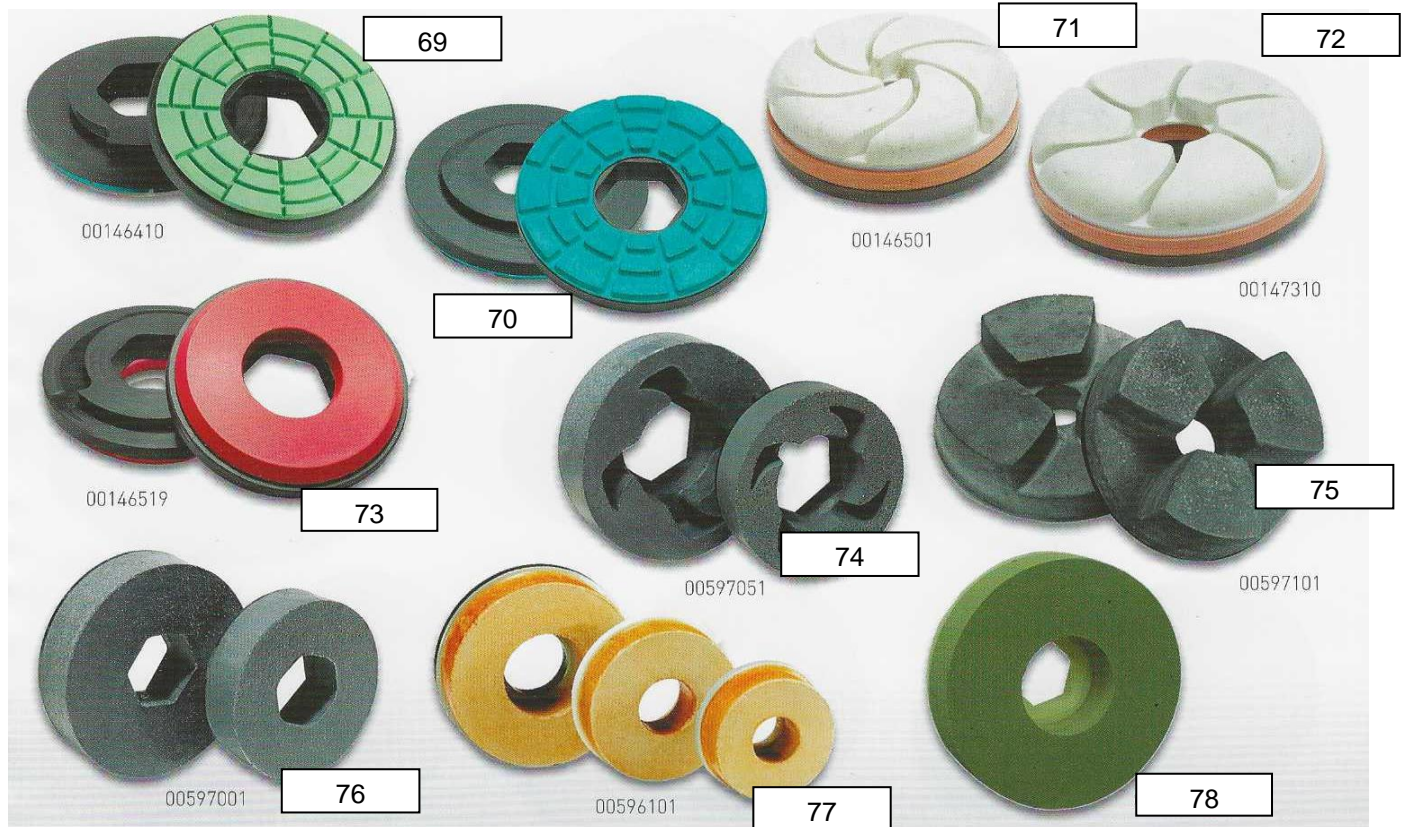
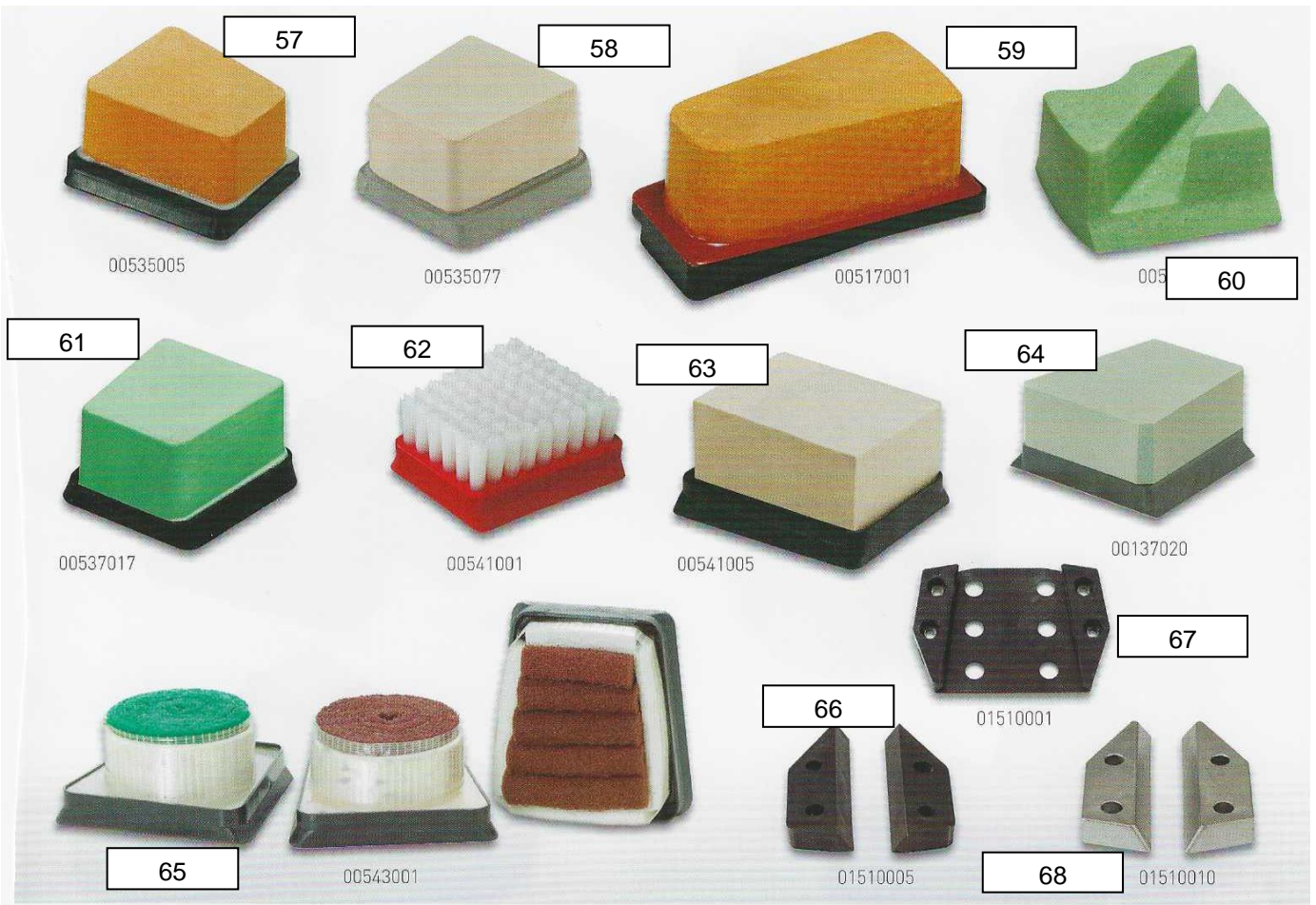



95

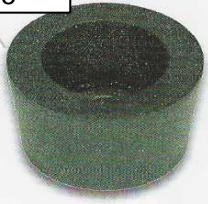

01020602



96

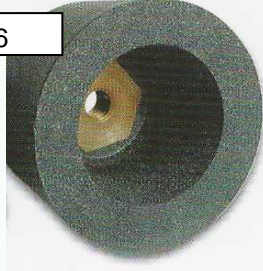

01020432



01020202

97



01020632

98



01025002

99

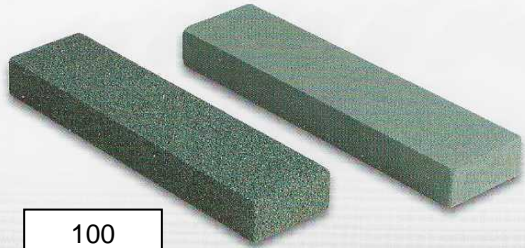

100

01030002

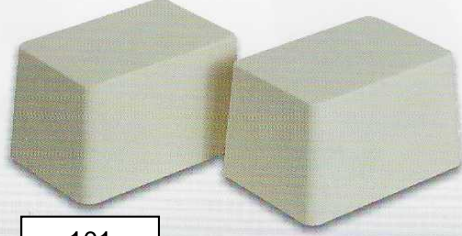

101

01032002

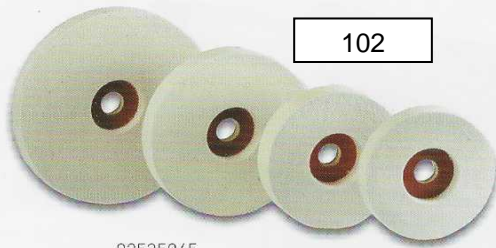

102

02535045

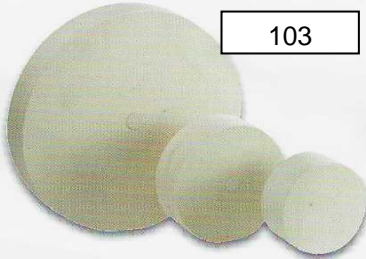

103

02535065



104

02535036

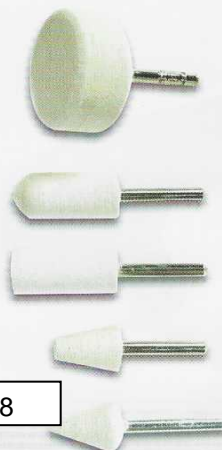

108

02535100

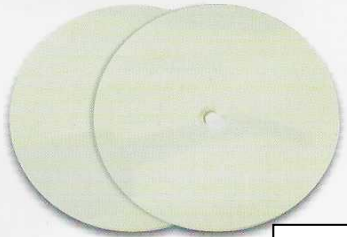

105

02535001

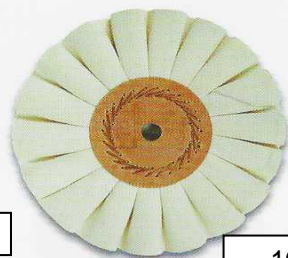

106

02535026



107

02535125



109

02535027

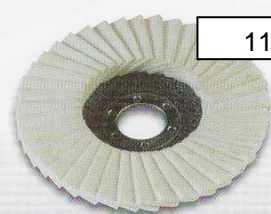

110

02535042

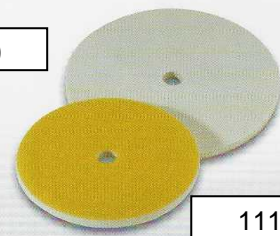

111

02535040



112

02535044



113

04010003

114

115



03555400

116



117

03555205



118

01025132



03530140

119



119

03530521



01030102

120



120

01515070



121

01515065



122

01515060



123

01515055



124

01515050



125

01515075



126

01505038



127

01505035



128

01505001



129

01505049

SPIDY

D. 130



D. 150

D. 130

ZIP

**LUCIDANO ANCHE CON LUCIDACOSTE A 4 MOTORI
O MOLTO VECCHIE**



130 BIS

STELLA

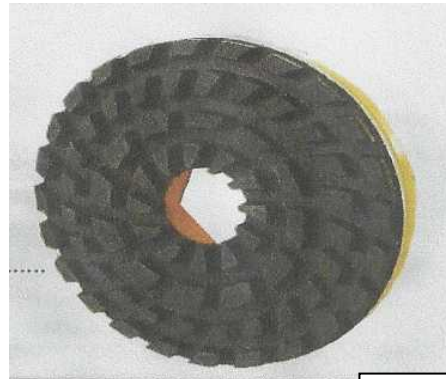

131 BIS

QUADRETTO

**L'UNICO IN GRADO DI UNIRE IL PREGIO DI UNA LUCIDATURA
SENZA EGUALI, SU TUTTI I TIPI DI LUCIDACOSTE E DI MATERIALI
FINO SPESSORI DI CM 10.
USARE AD ACQUA**

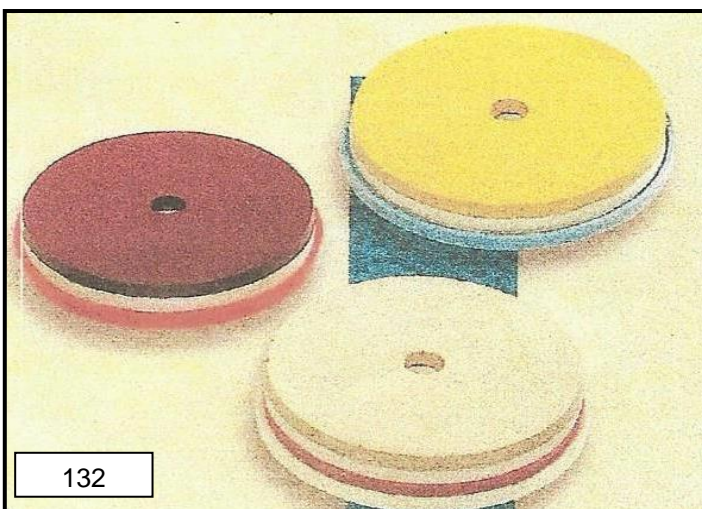

132

**TUTTO
TORO**

**LUCIDATORO
NEI D. 100 - 130 - 150**

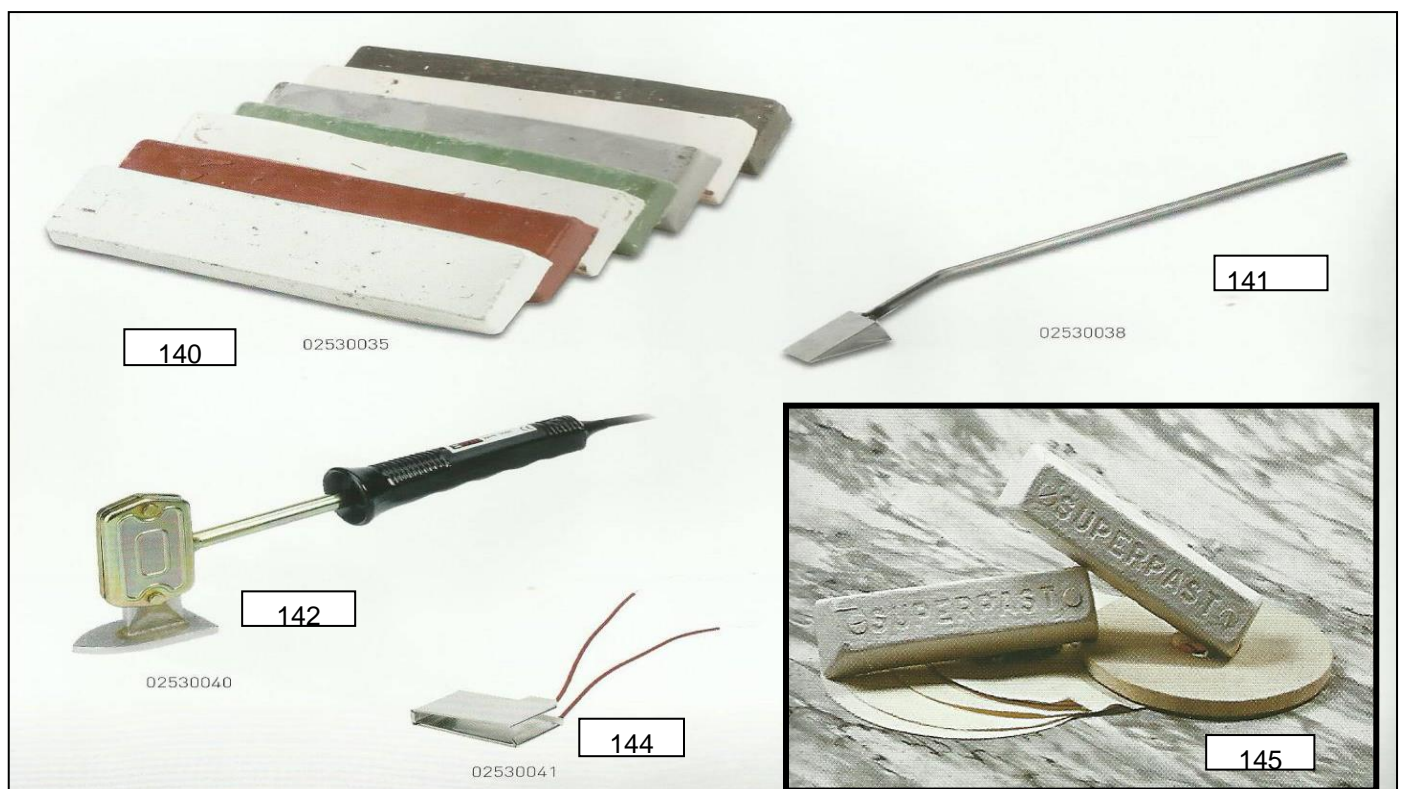
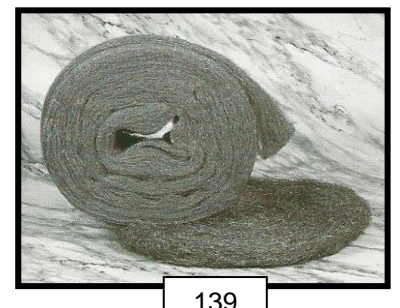
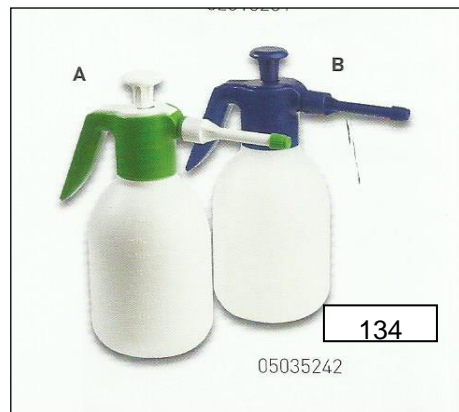

DISCHI COTONE E SISAL



146

- lucidatura e pulitura acciaio inox - *polishing and cleaning stainless steel*
- da utilizzare con paste abrasive - *to be used with abrasive paste*

Ø	Foro	Codice
150	20	DCS001
200	20	DCS002
250	20	DCS003
300	20	DCS004

DISCHI COTONE



147

- brillantatura metalli - *to make it metal bright*
- da utilizzare con paste abrasive - *to be used with abrasive paste*

Ø	Foro	Codice
150	20	DC001
200	20	DC002
250	20	DC003
300	20	DC004



149



150

05045255

153

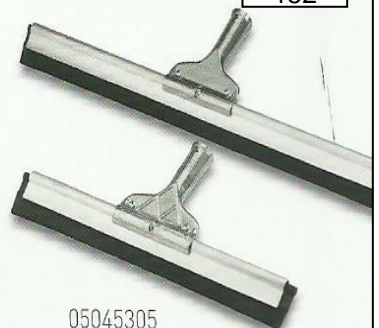

152

05045305

154

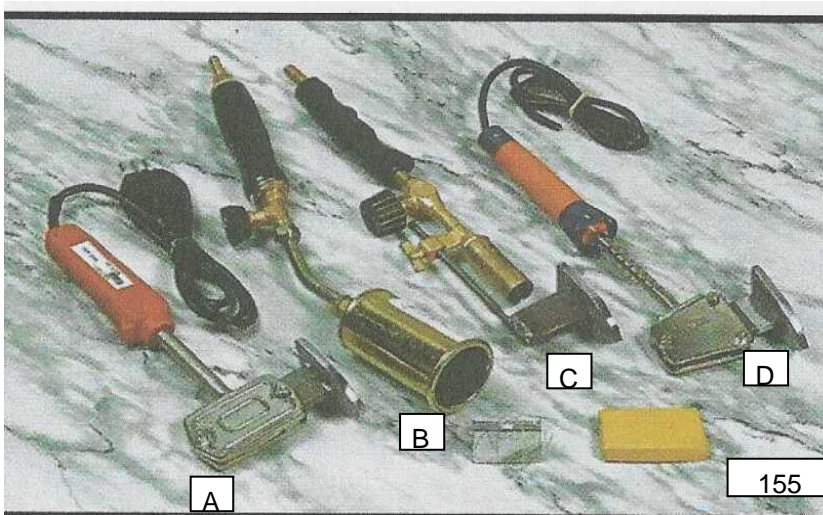

A

B

C

D

155



156



157

157 A



**SMUSSO CON SETTORI
DIAMANTATI
LUNGA DURATA SMUSSI
PERFETTI**
G. 60 - 120 - 220 - 320 - 400 -
D. 130

157 B



**LUCIDATORE
RESINOIDE DIAMANTATO
LUNGA DURATA
LUCIDATURA INEGUAGLIABILE**
G. 60 - 120 - 220 - 400 - 800 - 1500
DIAM. 130

157 C

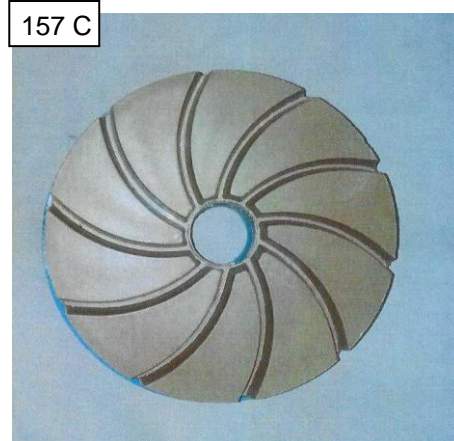

**LUCIDACOSTE
ECCEZIONALE SIA NEL PREZZO
CHE NEI RISULTATI**
D. 100 - 130
G. 36 - 60 - 100 - 200 - 400 - 800
1500 - 1800 - 3000 - 3500

157 D



**FAGIOLINO
NELLA VERSIONE
PER LUCIDACOSTE**
D.130 - 150
G. 36 - 60 - 100 - 220
400 - 800 - 1500 -
1800 - 3000
ADATTO SU TUTTI
I MATERIALI

157 E



LUCIDACOSTE
D. 130 - 150
SU TUTTI I GRANITI
D. 36 - 60 - 120 - 220
- 300 - 400 - 600 - 800
- 1000 - 1500 - 2000 -
3000.

157 F

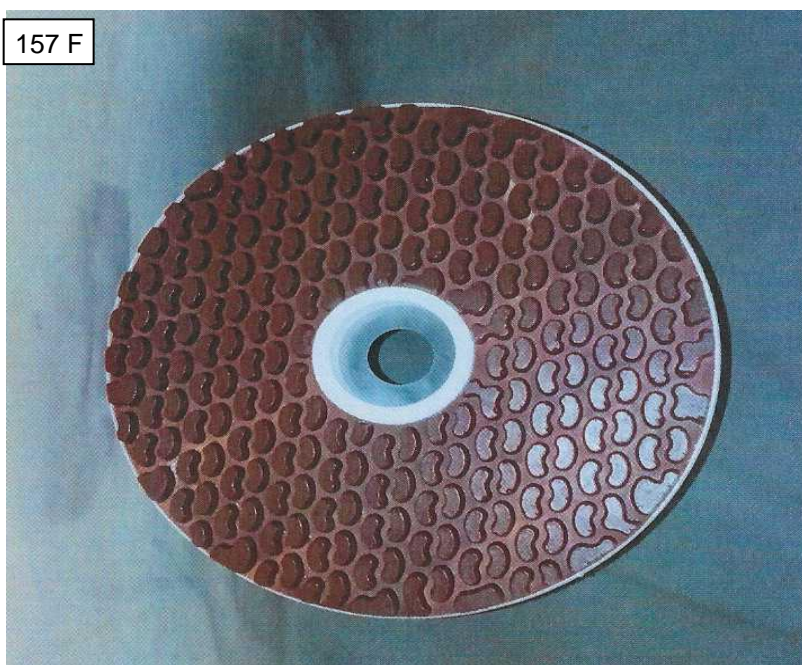

**FAGIOLINO
D. 240
CON ATTACCO MAGNETICO
ADATTO SU TUTTI I
MANETTONI
LUCIDANO
MARMO GRANITI GRES
NELLE GRANE**
50 - 60 - 120 - 220 - 400 - 800 -
1800 - 3000
IN PIU' NEL D. 240
SPECIALE FELTRO PER
BRILLANTARE